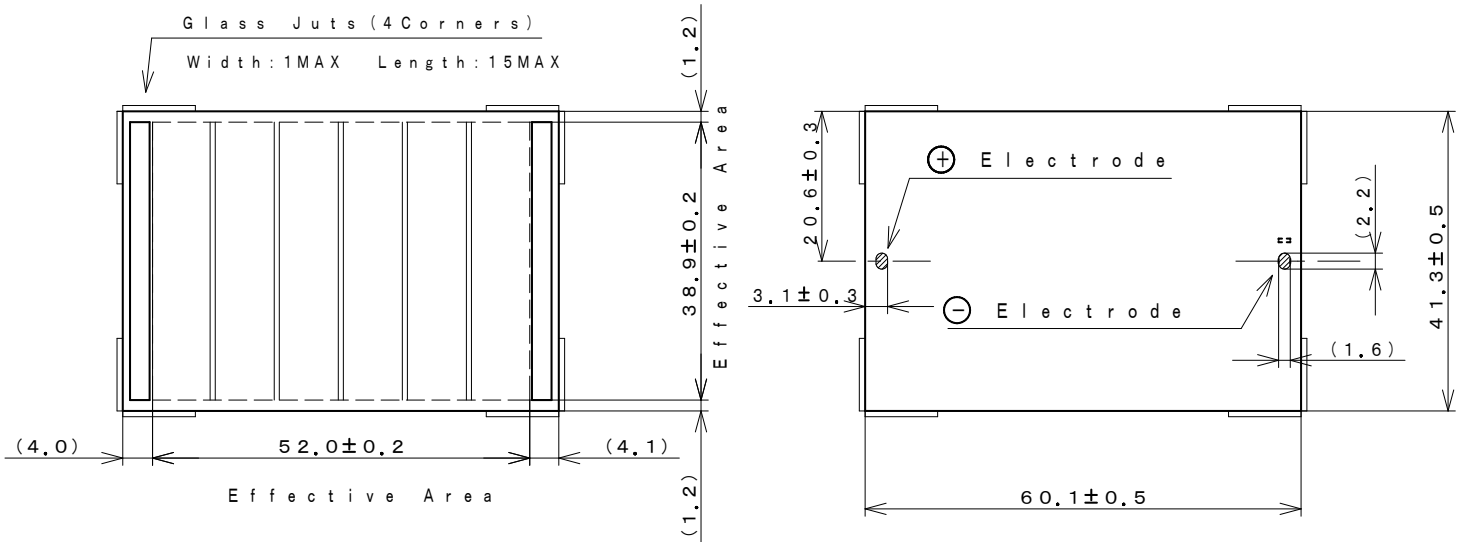

アモルファスシリコン太陽電池 仕様

Model : AM-5608C-T

1. Outside dimensions 外形寸法

Light Receiving Side (受光面)

Overcoat Side (オーハ[®]-コート面)

(dimension : mm)

Note

Glass Substrate Thickness (ガラス基板厚) : $1.6 \text{ mm} \pm 0.2$ Module Thickness (モジュール厚) : 2.0 mm MAX

Accepts normal soldering for bending

(一般の半田を使用してリート[®]線付けが可能です。)

2. Rated Specifications (at 25℃)

Item	Specifications (Initial)
2.1 Open circuit voltage : Voc 開放電圧	Typical 5.1V at 50kLx SS
2.2 Short circuit Current : Isc 短絡電流	Typical 17.8mA at 50kLx SS
2.3 Operating Voltage & Operating Current : Vope-Iope 動作特性	Minimum 3.0V - 12.5mA at 50kLx SS
	Typical 3.3V - 16.5mA at 50kLx SS
	Typical 3.3V - 36.0mA at AM-1.5 100mW/cm ²
2.4 Maximum output : Pmax & optimum operating Volt : Vop optimum operating Current : Iop 最大出力	(reference) 59mW Vop=3.9V Iop=15.1mA at 50kLx SS
	(reference) 125mW Vop=3.9V Iop=32.0mA at AM-1.5 100mW/cm ²
2.5 Working temperature range : Topr 動作温度範囲	-10 to 60℃
2.6 Storage temperature range : Tstg 保存温度範囲	-20 to 70℃

SS: Solar Simulator

アモルファスシリコン太陽電池 仕様

Model : AM-5608CAR-T

1. Outside dimensions 外形寸法

Light Receiving Side (受光面)

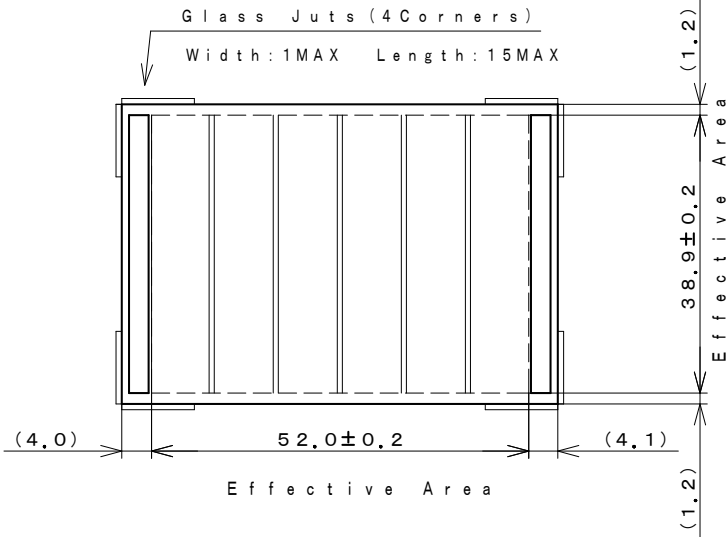

Overcoat Side (オーバーコート面)

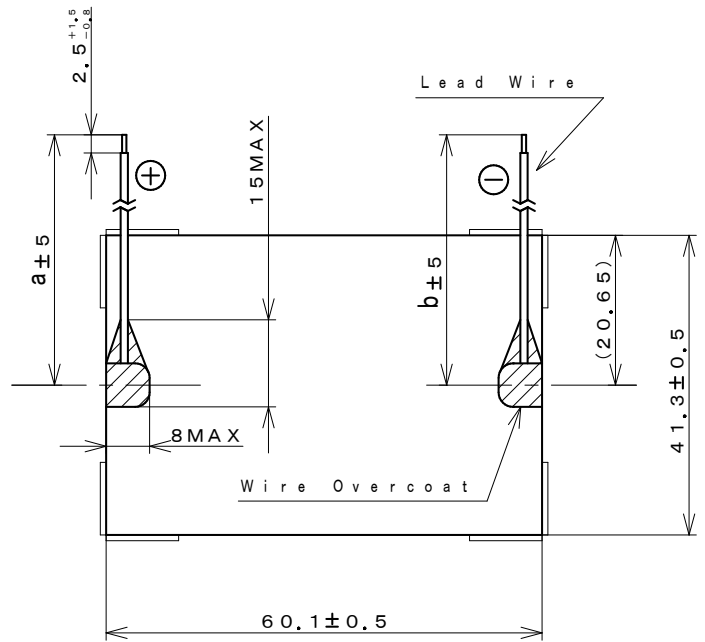

(dimension : mm)

Lead Wires : AWG28	
a : 100	b : 100

Note

Glass Substrate Thickness (ガラス基板厚) : 1.6mm ± 0.2
 Module Thickness (モジュール厚) : 2.0mm MAX
 Wire-Overcoat Thickness : 3.1mm MAX (including Module)
 (リード線補正コート厚)

2. Rated Specifications (at 25°C)

Item	Specifications (Initial)
2.1 Open circuit voltage : Voc 開放電圧	Typical 5.1V at 50kLx SS
2.2 Short circuit Current : Isc 短絡電流	Typical 17.8mA at 50kLx SS
2.3 Operating Voltage & Operating Current : Vope-Iope 動作特性	Minimum 3.0V - 12.5mA at 50kLx SS
	Typical 3.3V - 16.5mA at 50kLx SS
	Typical 3.3V - 36.0mA at AM-1.5 100mW/cm ²
2.4 Maximum output : Pmax & optimum operating Volt : Vop optimum operating Current : Iop 最大出力	(reference) 59mW Vop=3.9V Iop=15.1mA at 50kLx SS
	(reference) 125mW Vop=3.9V Iop=32.0mA at AM-1.5 100mW/cm ²
2.5 Working temperature range : Topr 動作温度範囲	-10 to 60°C
2.6 Storage temperature range : Tstg 保存温度範囲	-20 to 70°C

I - V Characteristics

REFERENCE

1.Model : AM-5608

2.Outside Dimension : 60.1mm × 41.3mm

SS:Solar Simulator

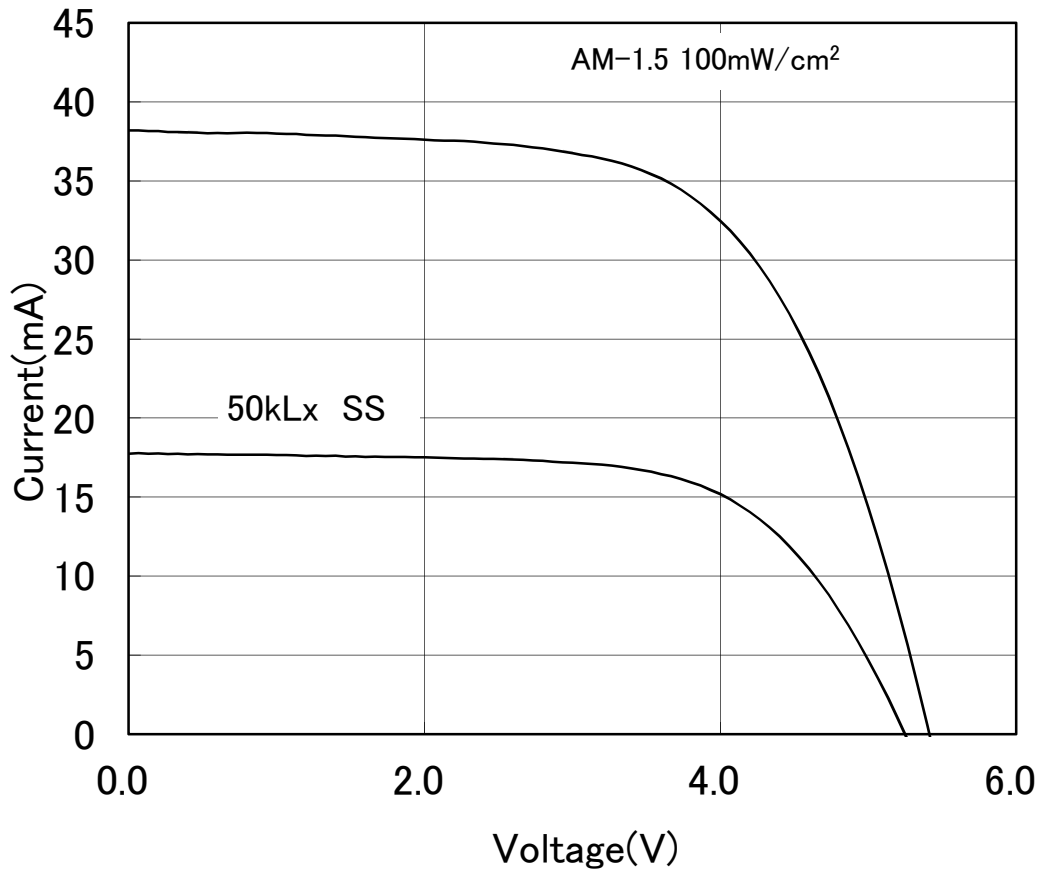

*このデータは標準的な出力特性を示すものであり、特性を保証するものではありません。

*The data are meant to show standard electric characteristics only , not intended to guarantee the characteristics.

Panasonic Solar Amorton Co.,Ltd.

2019/5/30

出力の照度依存特性

REFERENCE

Dependence of Output on Illumination

1.Model : AM-5608

2.Outside Dimension : 60.1mm × 41.3mm

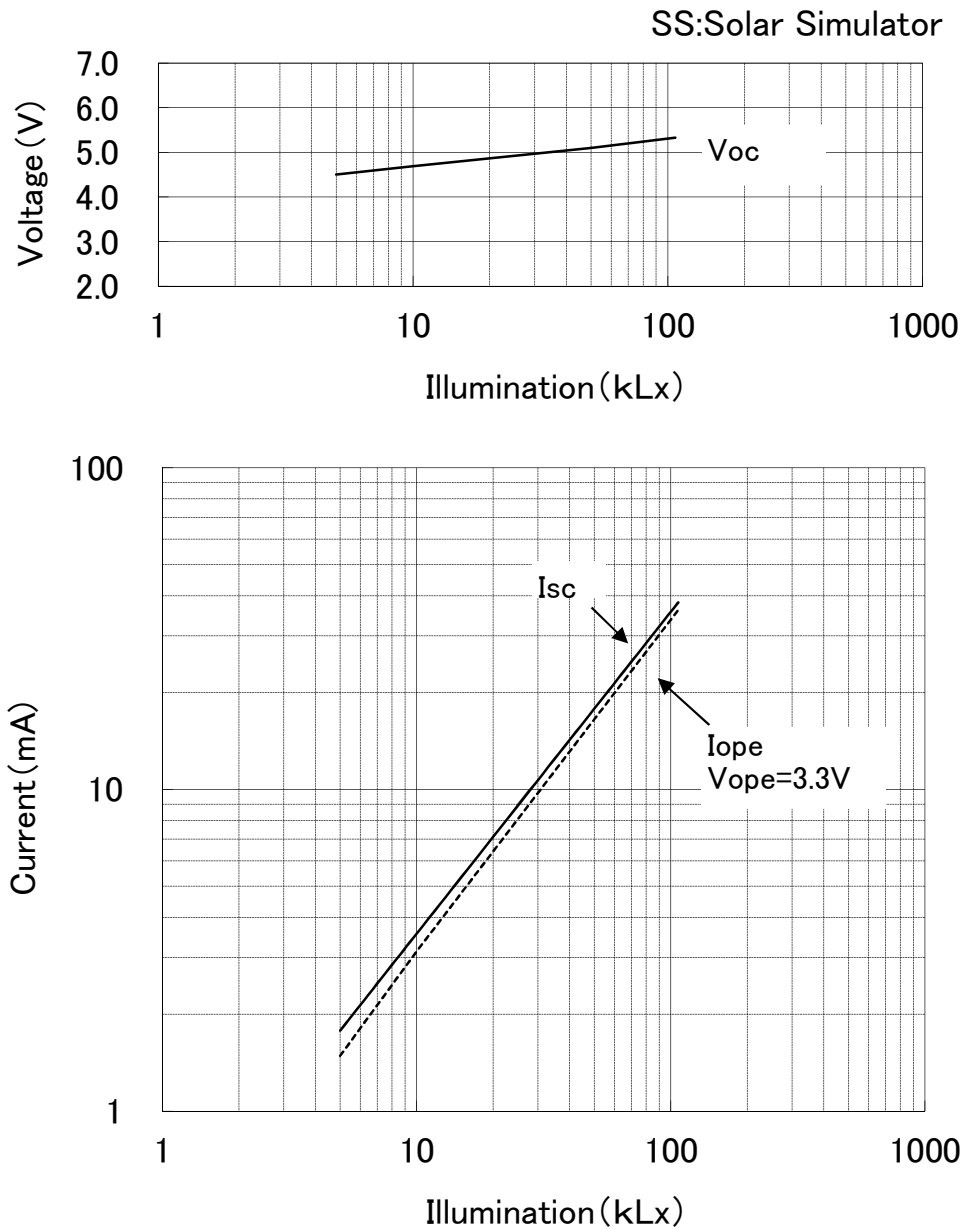

*このデータは標準的な出力特性を示すものであり、特性を保証するものではありません。

*The data are meant to show standard electric characteristics only , not intended to guarantee the characteristics.

Panasonic Solar Amorton Co.,Ltd.

2019/5/30

出力の温度依存特性

REFERENCE

Dependence of Output on Temperature

1.Model : AM-5608

2.Outside Dimension : 60.1mm × 41.3mm

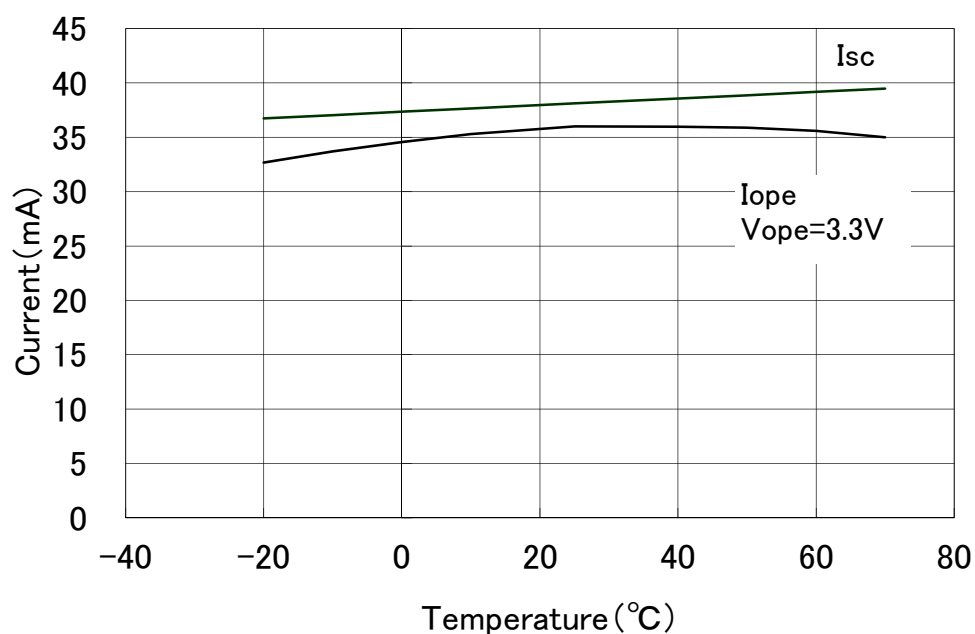
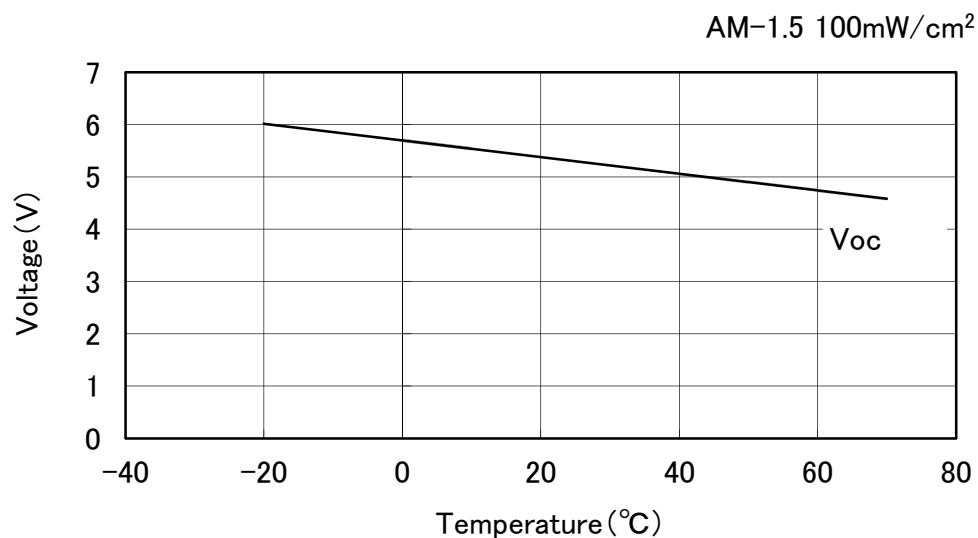

*このデータは標準的な出力特性を示すものであり、特性を保証するものではありません。

*The data are meant to show standard electric characteristics only , not intended to guarantee the characteristics.