

Model : AM-1801C

1. Outside dimensions 外形寸法

Light Receiving Side (受光面)

Overcoat Side (オーバーコート面)

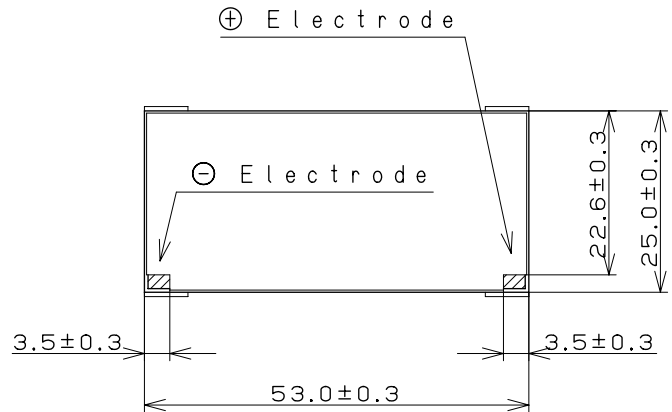
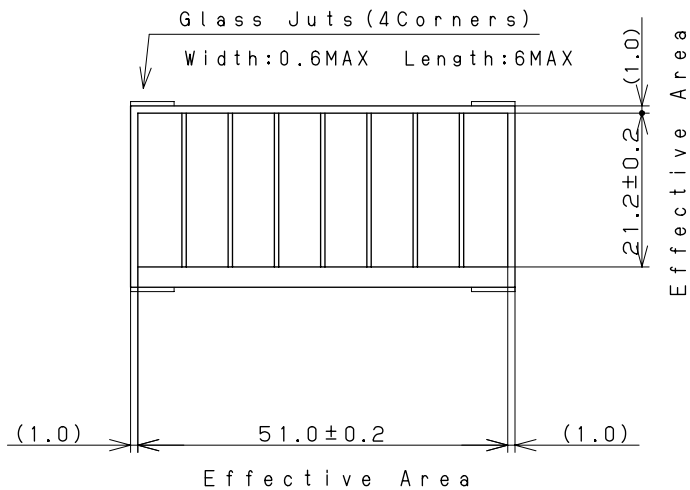

(dimension: mm)

Note

Glass Substrate Thickness (ガラス基板厚) : 1.1mm±0.1

Module Thickness (モジュール厚) : 1.3mmMAX

Accepts normal soldering for bending

(一般の半田を使用してリート線付けが可能です。)

2. Rated Specifications (at 25°C)

Item	Specifications (Initial)		
2.1 Open circuit voltage: Voc 開放電圧	Typical	5.0V	at 200Lx FL
2.2 Short circuit Current: Isc 短絡電流	Typical	20.2μA	at 200Lx FL
2.3 Operating Voltage & Operating Current: Vope-lope 動作特性	Typical	2.6V - 4.6μA	at 50Lx FL
	Minimum	3.0V - 12.0μA	at 200Lx FL
	Typical	3.0V - 18.9μA	at 200Lx FL
2.5 Working temperature range: Topr 動作温度範囲	-10 to 60°C		
2.6 Storage temperature range: Tstg 保存温度範囲	-20 to 70°C		
2.7 Working illuminance range 使用照度範囲	~1000Lx		

FL: White Fluorescent Light

アモルファスシリコン太陽電池 仕様

Model : AM-1801CA

1. Outside dimensions 外形寸法

Light Receiving Side (受光面)

Overcoat Side (オーバーコート面)

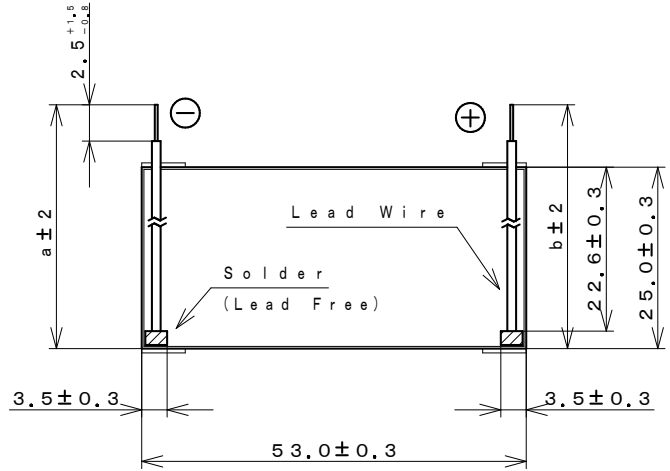
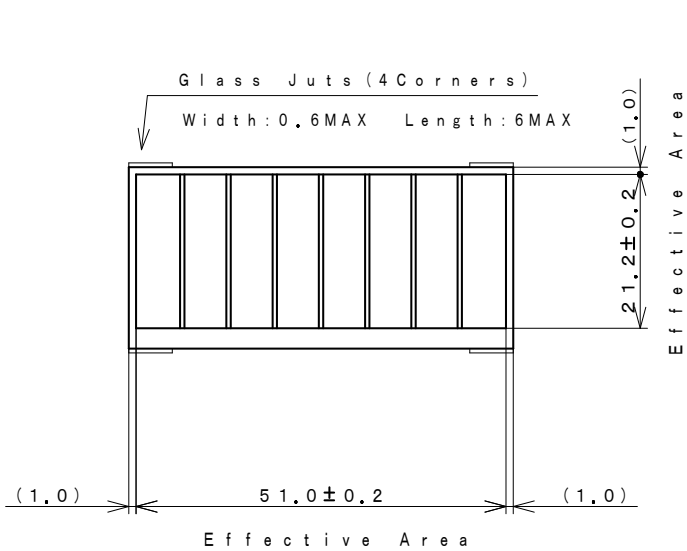

(dimension : mm)

Lead Wires : AWG28
a : 51 b : 51

Note

Glass Substrate Thickness (ガラス基板厚) : 1.1mm ± 0.1

Module Thickness (モジュール厚) : 1.3mm MAX

Wire-Solder thickness : 2.5mm MAX (including Module)

(リード線半田付け部厚)

2. Rated Specifications (at 25°C)

Item	Specifications (Initial)
2.1 Open circuit voltage : Voc 開放電圧	Typical 5.0V at 200Lx FL
2.2 Short circuit Current : Isc 短絡電流	Typical 20.2 μA at 200Lx FL
2.3 Operating Voltage & Operating Current : Vope - Iope 動作特性	Typical 2.6V - 4.6 μA at 50Lx FL
	Minimum 3.0V - 12.0 μA at 200Lx FL
	Typical 3.0V - 18.9 μA at 200Lx FL
2.5 Working temperature range : Topr 動作温度範囲	-10 to 60°C
2.6 Storage temperature range : Tstg 保存温度範囲	-20 to 70°C
2.7 Working illuminance range 使用照度範囲	~ 1000Lx

FL: White Fluorescent Light

I - V Characteristics

REFERENCE

1. Model : AM-1801

2. Outside Dimension : 53.0mm × 25.0mm

FL: White Fluorescent Light

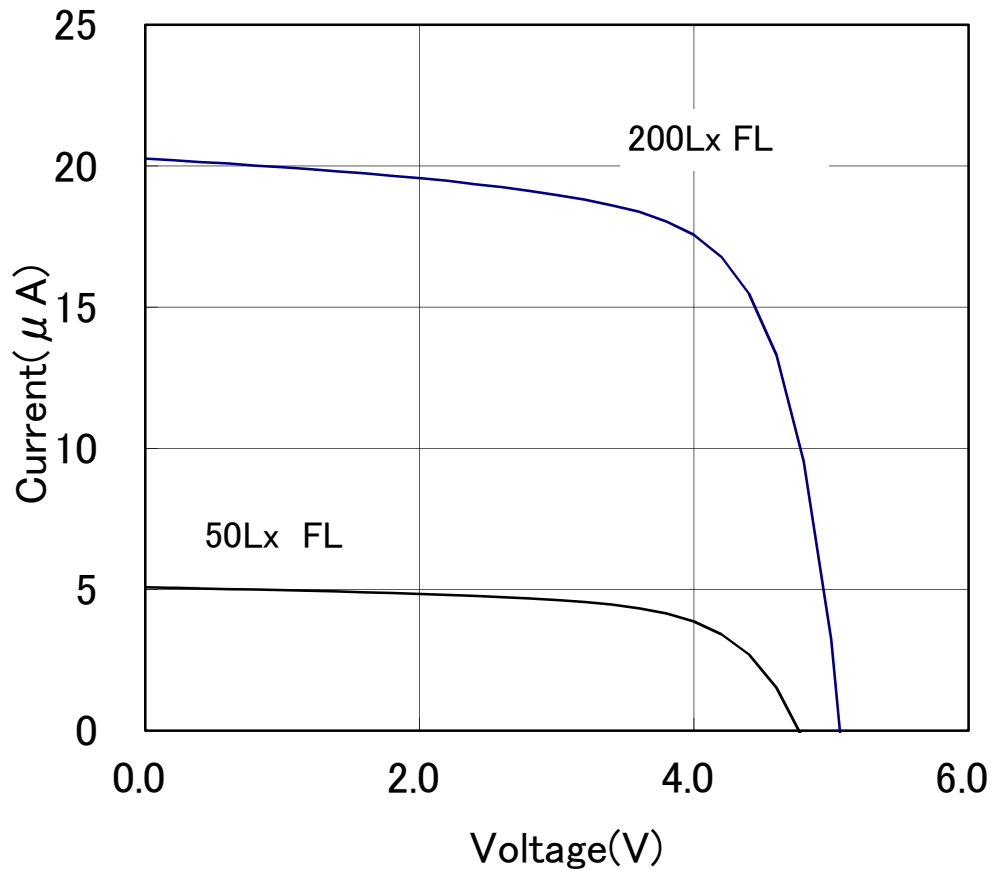

*このデータは標準的な出力特性を示すものであり、特性を保証するものではありません。

*The data are meant to show standard electric characteristics only , not intended to guarantee the characteristics.

Panasonic Solar Amorton Co.,Ltd.

2019/4/26

出力の照度依存特性

REFERENCE

Dependence of Output on Illumination

1.Model : AM-1801

2.Outside Dimension : 53.0mm × 25.0mm

FL:White Fluorescent Light

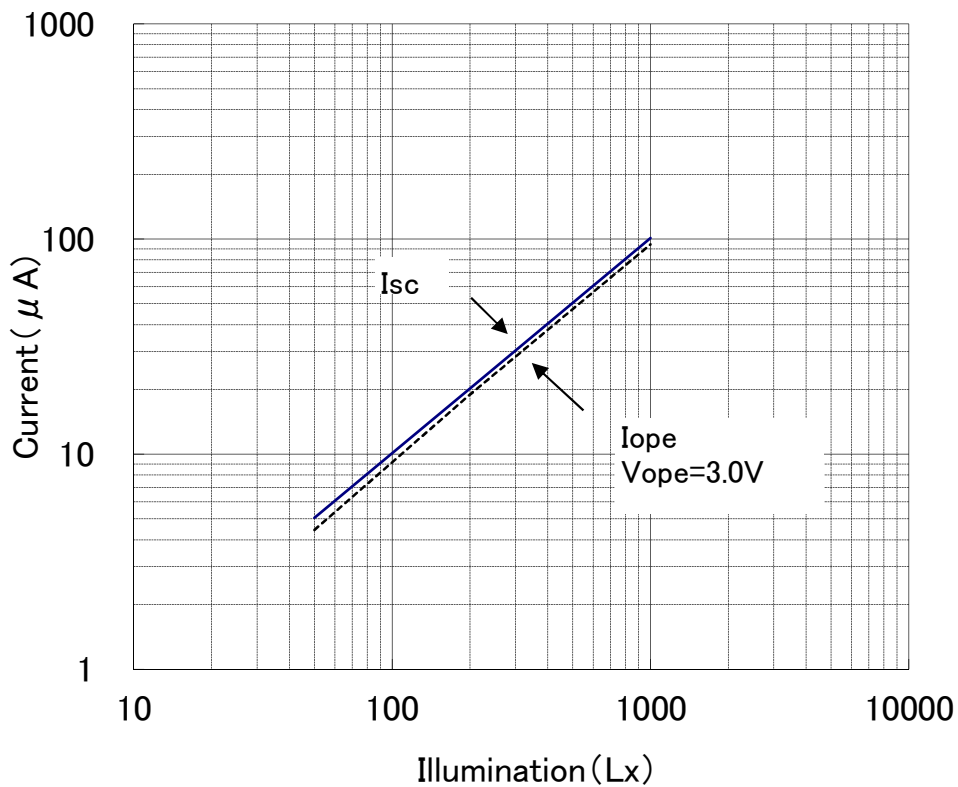
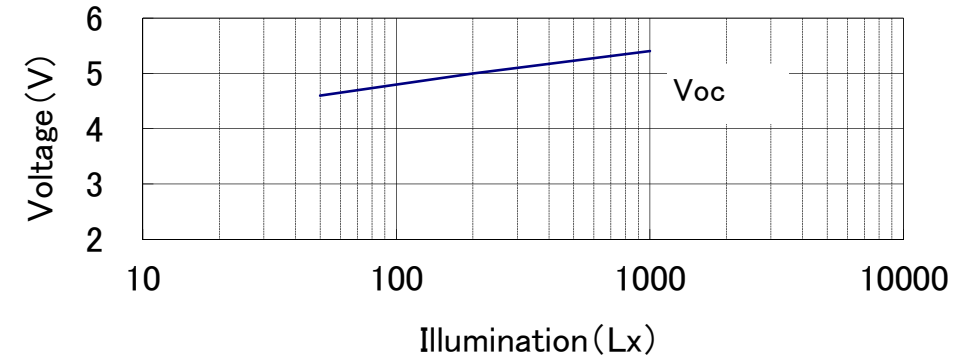

*このデータは標準的な出力特性を示すものであり、特性を保証するものではありません。

*The data are meant to show standard electric characteristics only , not intended to guarantee the characteristics.

出力の温度依存特性

REFERENCE

Dependence of Output on Temperature

1.Model : AM-1801

2.Outside Dimension : 53.0mm × 25.0mm

at 200Lx White Fluorescent Light

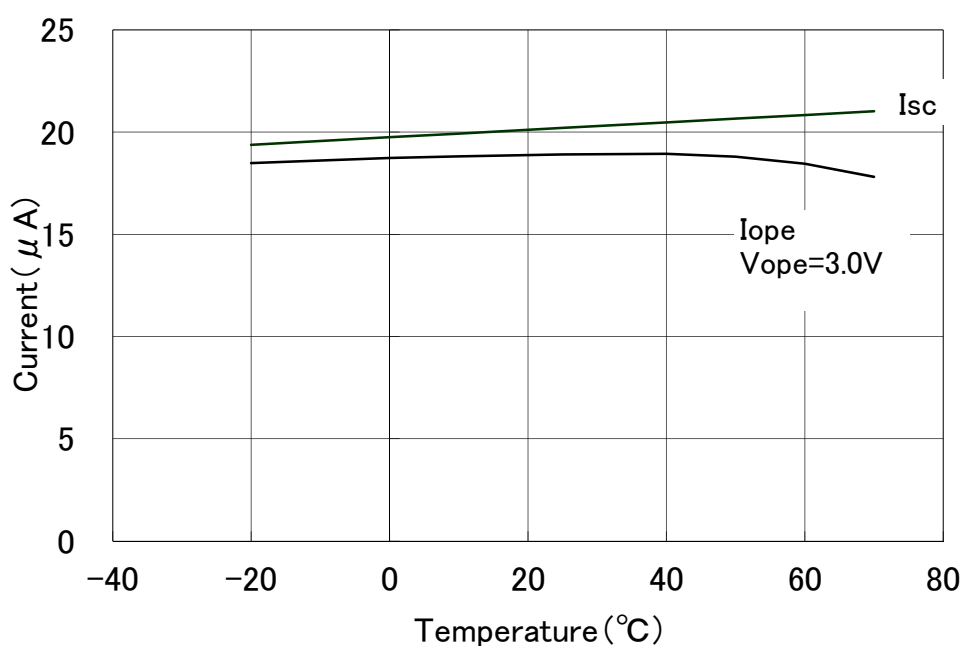
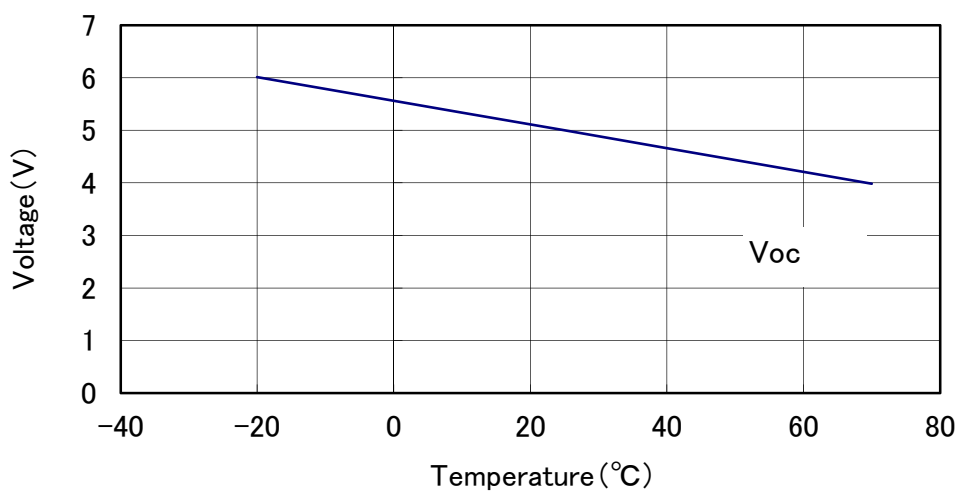

*このデータは標準的な出力特性を示すものであり、特性を保証するものではありません。

*The data are meant to show standard electric characteristics only , not intended to guarantee the characteristics.