

Model : AM-1456C

1. Outside dimensions 外形寸法

Light Receiving Side (受光面)

Overcoat Side (オーバーコート面)

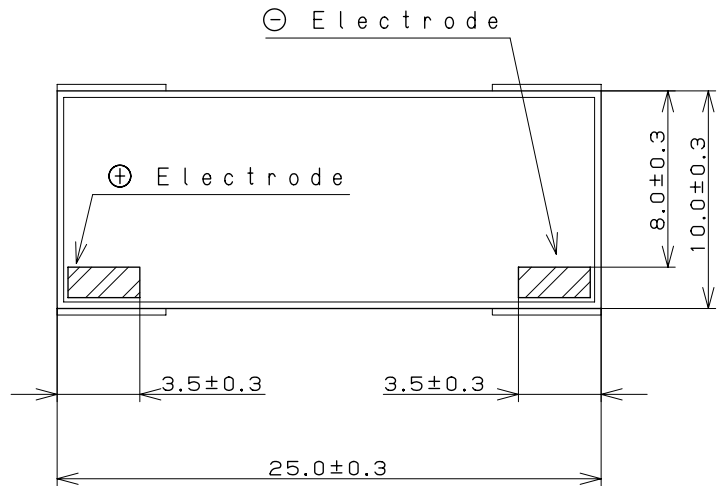
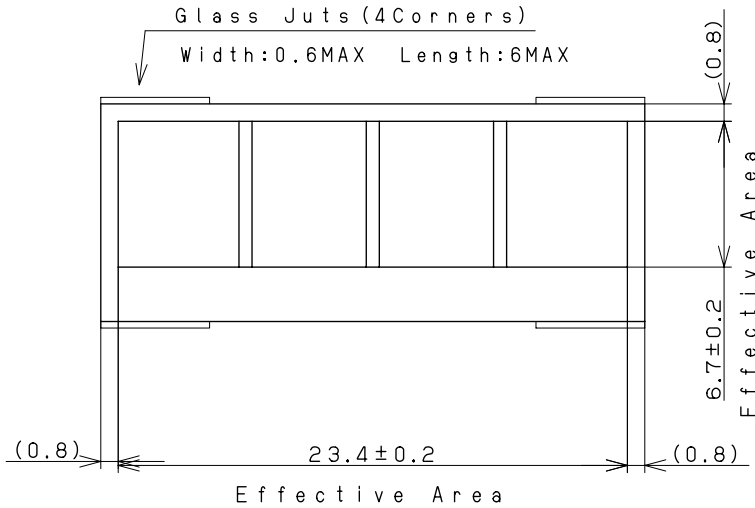

(dimension: mm)

Note

Glass Substrate Thickness (ガラス基板厚) : 1.1mm ± 0.1
 Module Thickness (モジュール厚) : 1.3mm MAX
 Accepts normal soldering for bending
 (一般の半田を使用してリード線付けが可能です。)

2. Rated Specifications (at 25°C)

Item	Specifications (Initial)		
2.1 Open circuit voltage: Voc 開放電圧	Typical	2.5V	at 200Lx FL
2.2 Short circuit Current: Isc 短絡電流	Typical	6.4 μA	at 200Lx FL
2.3 Operating Voltage & Operating Current: Vope-lope 動作特性	Typical	1.4V - 1.3 μA	at 50Lx FL
	Minimum	1.5V - 4.0 μA	at 200Lx FL
	Typical	1.5V - 5.9 μA	at 200Lx FL
2.5 Working temperature range: Topr 動作温度範囲	-10 to 60°C		
2.6 Storage temperature range: Tstg 保存温度範囲	-20 to 70°C		
2.7 Working illuminance range 使用照度範囲	~1000Lx		

FL: White Fluorescent Light

Model : AM-1456CA

1. Outside dimensions 外形寸法

Light Receiving Side (受光面)

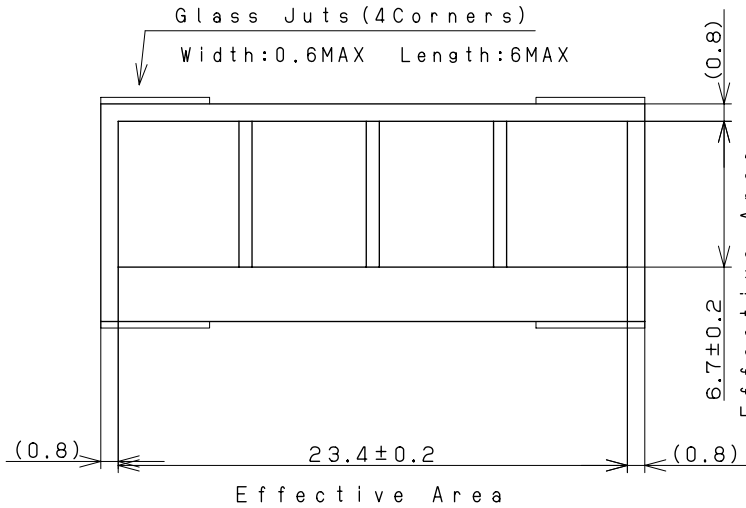

Overcoat Side (オーバーコート面)

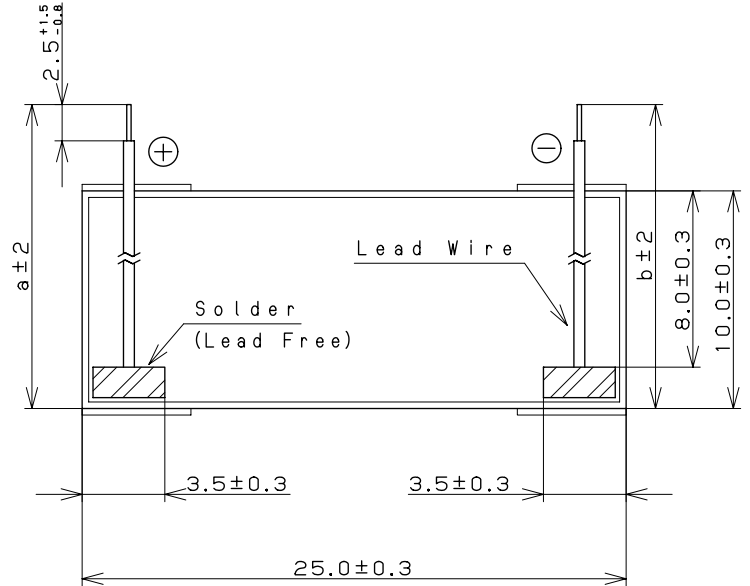

(dimension: mm)

Lead Wires : AWG30	
a: 51	b: 51

Note

Glass Substrate Thickness (ガラス基板厚) : 1.1mm ± 0.1
 Module Thickness (モジュール厚) : 1.3mm MAX
 Wire-Solder thickness: 2.5mm MAX (including Module)
 (リード線半田付け部厚)

2. Rated Specifications (at 25°C)

Item	Specifications (Initial)		
2.1 Open circuit voltage: Voc 開放電圧	Typical	2.5V	at 200Lx FL
2.2 Short circuit Current: Isc 短絡電流	Typical	6.4 μA	at 200Lx FL
2.3 Operating Voltage & Operating Current: Vope-lope 動作特性	Typical	1.4V - 1.3 μA	at 50Lx FL
	Minimum	1.5V - 4.0 μA	at 200Lx FL
	Typical	1.5V - 5.9 μA	at 200Lx FL
2.5 Working temperature range: Topr 動作温度範囲	-10 to 60°C		
2.6 Storage temperature range: Tstg 保存温度範囲	-20 to 70°C		
2.7 Working illuminance range 使用照度範囲	~1000Lx		

FL: White Fluorescent Light

I - V Characteristics

REFERENCE

1. Model : AM-1456

2. Outside Dimension : 25.0mm × 10.0mm

FL: White Fluorescent Light

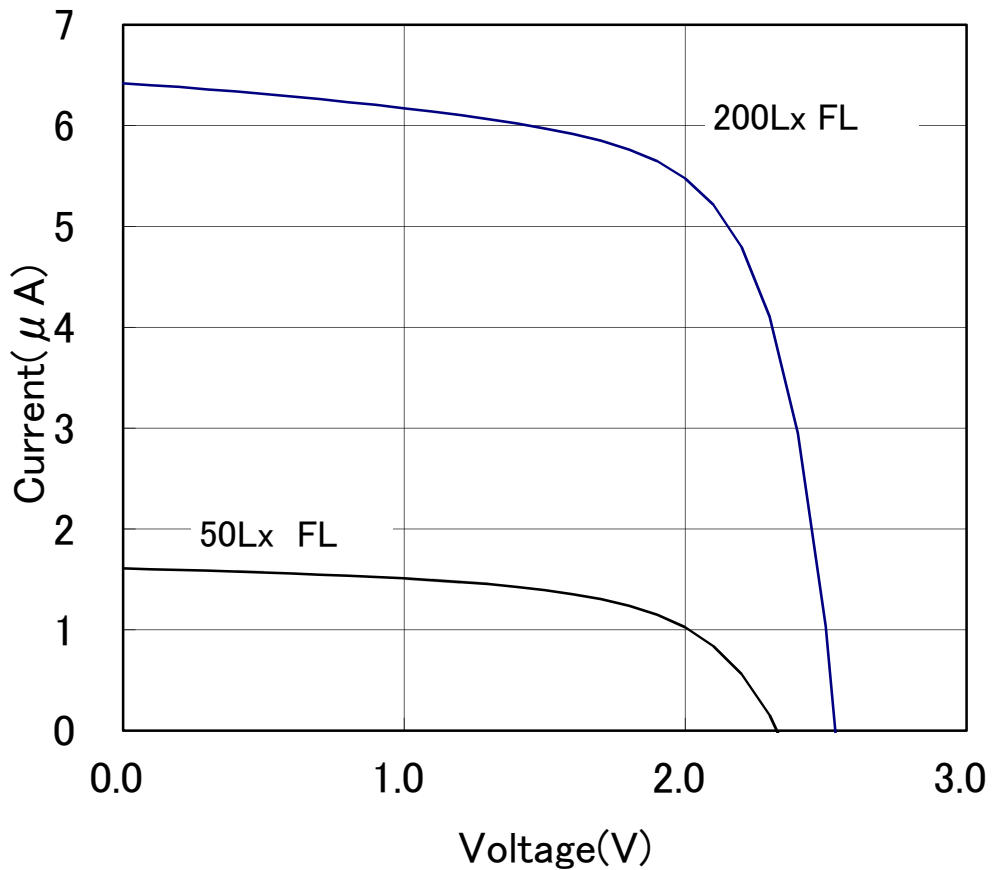

*このデータは標準的な出力特性を示すものであり、特性を保証するものではありません。

*The data are meant to show standard electric characteristics only , not intended to guarantee the characteristics.

Panasonic Solar Amorton Co.,Ltd.

2019/4/25

出力の照度依存特性

REFERENCE

Dependence of Output on Illumination

1.Model : AM-1456

2.Outside Dimension : 25.0mm × 10.0mm

FL:White Fluorescent Light

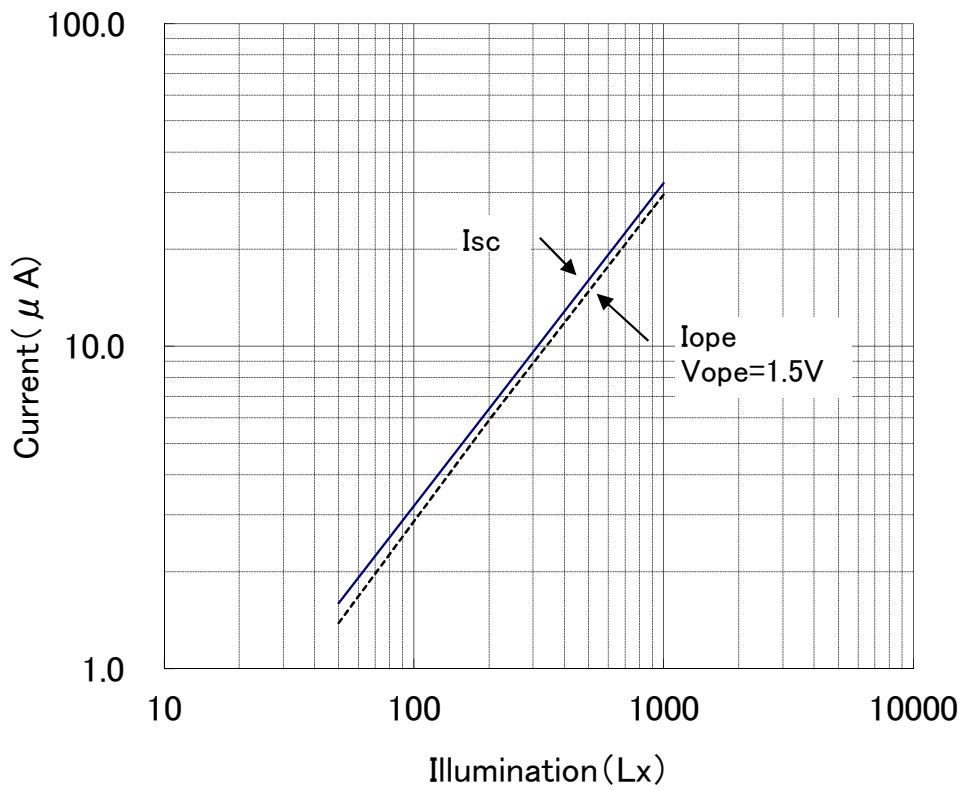
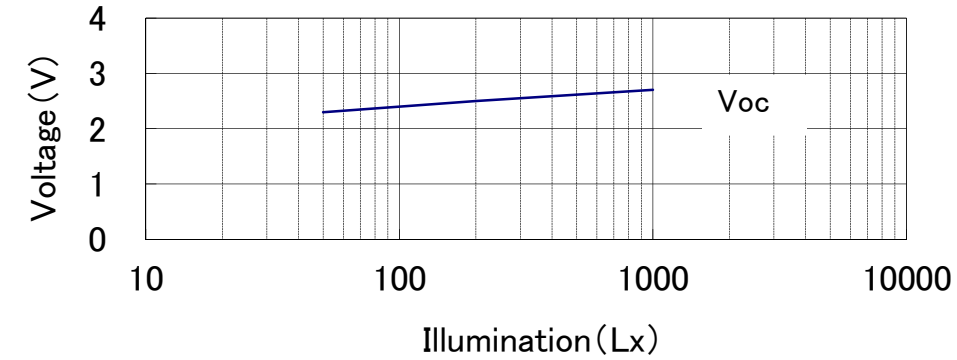

*このデータは標準的な出力特性を示すものであり、特性を保証するものではありません。

*The data are meant to show standard electric characteristics only , not intended to guarantee the characteristics.

出力の温度依存特性

REFERENCE

Dependence of Output on Temperature

1.Model : AM-1456

2.Outside Dimension : 25.0mm × 10.0mm

at 200Lx White Fluorescent Light

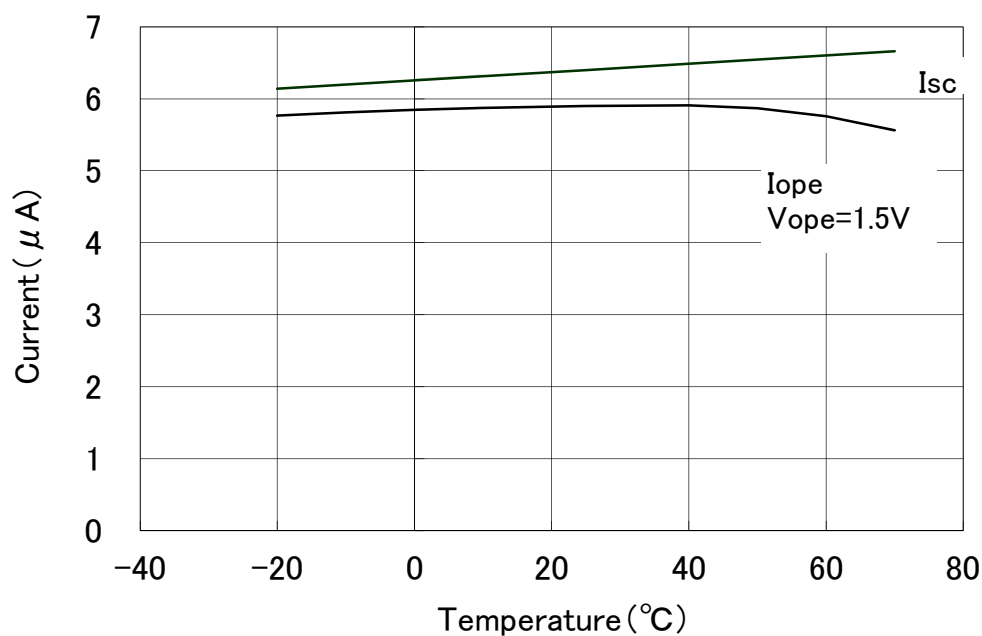
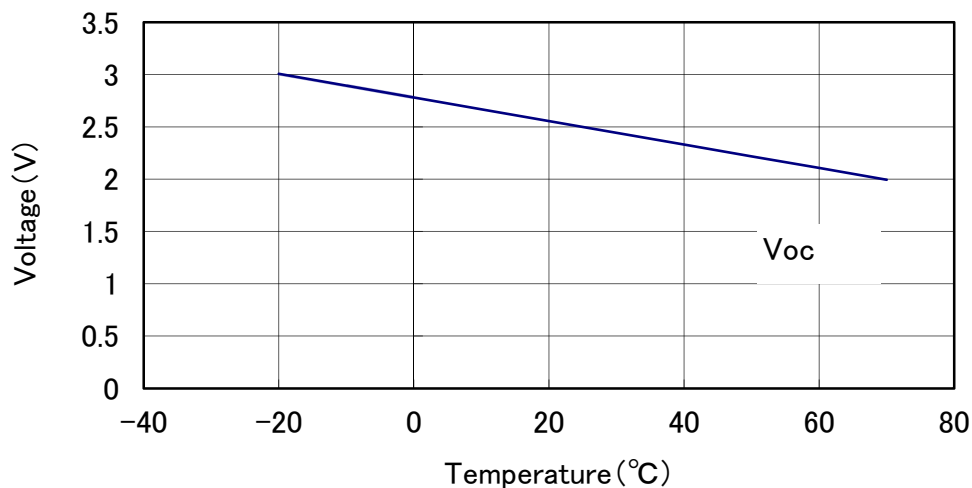

*このデータは標準的な出力特性を示すものであり、特性を保証するものではありません。

*The data are meant to show standard electric characteristics only , not intended to guarantee the characteristics.